

Thermo Recorder

Measures and Records Temperatures from

-200 to 600 °C



By connecting the TR-81 to a platinum resistance sensor (Pt 100) you can easily and accurately measure and record temperatures within a broad range.

Pt100

〈 PAT.P.〉

CE

Pt100-based type **TR-81**

Expand the possibilities.

TR-81 extends temperature data collection and management to the range of -200 to 600 °C

Measurement and Recording



Data Collection



Connect to Computer

Easy Computer Processing



※Image created for display purpose.

Adaptable to any Three-wired Platinum Resistance Sensor

TR-81 has been designed for use with any three-wired Pt 100-type sensor. It can be easily attached to already fixed sensors for a wide range of uses from personal to business.



1 Unit has 2 Measuring and Recording Channels

You can measure and record with two channels on one unit. Present temperature readings are flashed alternately on the main unit's display giving you up to the second readings on an easy-to-read display

Large Data Capacity

Each channel is capable of recording up to 8,000 readings. At a recording interval of 1 hour that gives you about one year of continual recording. It is possible to change batteries in the middle of a long-term recording and not lose data.

Easy to Read Multi-Functional Display

The easy to read large sized LCD displays present readings, recording conditions, battery life warning, amount of data readings, and the unit of measurement among other things.

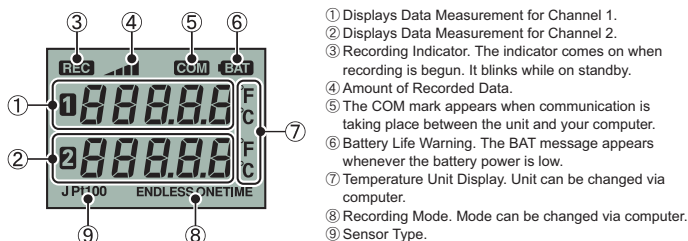

Reliable Backup Function

We have eliminated the worry of losing data due to a loss of power.

When Battery Power becomes Low

When battery power becomes low a battery life warning will appear on the unit's display indicating that the battery should be changed. If within a short time the battery is changed, measurement and recording will not be interrupted and there will be no data loss. If the battery is not changed, the unit will automatically go into SLEEP mode whereby measurement and recording will stop. But, due to our BACK UP FUNCTION data will not be lost and will remain saved for one year.



Note:

Even if the unit is in sleep mode it needs battery power. Hence a total loss of battery power or removal of the batteries will result in the loss of data.

5-8 Month Continual Recording on 1 Battery

Using our specially designed low energy consumption circuit this unit can run on one Lithium battery for five to eight months of continued use. No need to worry about where you place it, as the battery will allow you to measure and record over long periods of time whether the unit is in transit or in a distant place.

Note:

Battery life will depend on the recording environment, recording interval, communication frequency, and ambient temperature. The above battery life test was carried out using brand new batteries and in no way do we guarantee a battery's life.

15 Recording Intervals / 2 Recording Methods

Depending on your recording needs you can choose from one of 15 different recording intervals (1 second to 1 hour). There are also two methods of recording: One-time method: Recording stops when recorded data readings reach 8,000.

Endless method: When recorded readings reach 8,000 the oldest data is overwritten and recording continues.

One Touch Sensor Connector TR-08P1 (Option)

When the sensor your using has been permanently fixed, this one touch sensor connector saves you time and effort in connecting and disconnecting the main unit from the sensor.

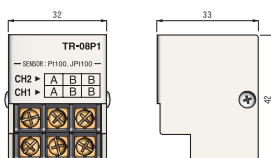

Software Included with TR-81

Hi for Windows®

Easy-to-use Windows software allows you to control all aspects of set up, recording and downloading as well as printing, creating text files, tables and colorful graphs of the recorded data.

Up to 8 Channels of Data in One Graph

By simply downloading the data from the main unit a colorful graph representing that data will be automatically created. Up to 8 channels (4 units) of data can be represented in one graph. Moreover, you can easily hide and view channels, make changes to graph colors and zoom-in and -out on data with the click of a mouse.

Temp/Humidity Graph

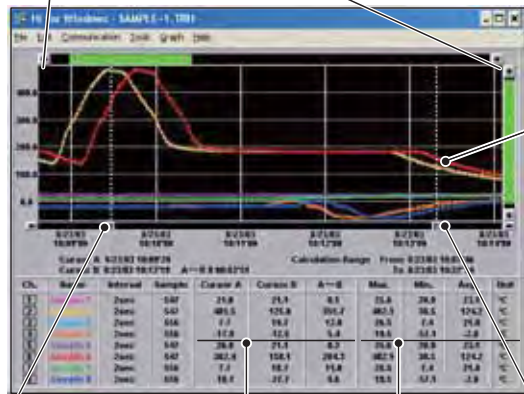
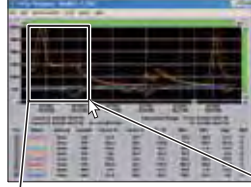

A Cursor Bar Cursor values and calculated difference Max. / Min. / Average / Unit B Cursor Bar

- By moving the cursors onto a specific date and time you can easily view recorded temp. data as well as the calculated differences between date A and B.
- By selecting a calculation range you can have displayed the High, Low and Average Temperatures for that chosen period.

Data Tables / Programmed Recording Start

You can display the data in table form. The High, Low and Average temperatures will be displayed in different colors for easy viewing. By using the Programmed Start function you can set up recording for a unit to begin on a certain day at a desired time.

Data List Display



Recording Settings Window

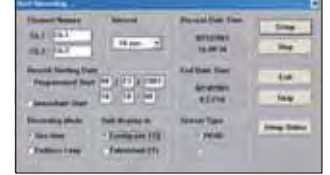

Graph / Table Printing Function

You can print out in color or monochrome the graphs just as they appear on your screen. You can also print out in table form all of the data in order of date and time.

Color Graph Printing

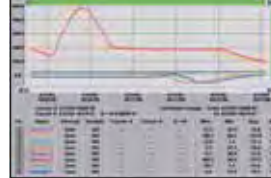

Monochrome Graph Printing

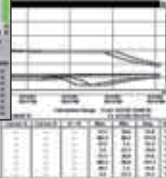

Data List



Save as Text File Function

This function allows you to save data in Text File Format (CSV Format) in order to use the data with spreadsheet applications such as Excel and Lotus.

Sensors for TR-81 (Option) TR-81XX

Our sensors are produced only upon order, therefore please allow three weeks from time of order until shipping.

Sensor Specifications		Sensor Device	Pt100	Insulation Resistance	DC500V Over 10MΩ	Range of Error	±(0.15+0.002×t)°C (t: absolute value of measurement)
	Electrical Current		less than 2 mA	Conductor	3 wire type	Water Resistance	None (only stainless protection pipe is water resistant)

Sensor Types

TR-81 **A** - **B** - **C** - **D** M

Type Protection Pipe Diameter Protection Pipe Length Cable Length

A Sensor Type

TR-8100-

Economical Type
Measurement Range: -50 to 200°C
Thermal Constant Time:
In agitated water: about 4.5 seconds ※1

TR-8110-

Regular Type
Measurement Range: -50 to 350°C
Thermal Constant Time:
In agitated water: about 2 seconds ※1

TR-8120-

Low to High Temp Type
Measurement Range: -200 to 600°C
Thermal Constant Time:
In agitated water: about 2 seconds ※1

TR-8130-

Handy Type
Measurement Range: -50 to 200°C
Thermal Constant Time:
In agitated water: about 2.5 seconds ※1

B Sensor Protection Pipe Diameter

◎ Recommended ○ Available — Not available

Protection Pipe Diameter	TR-8100	TR-8110	TR-8120	TR-8130
φ 2. 3	○	○	○	—
φ 3. 0	○	○	○	—
φ 3. 2	◎	◎	◎	◎
φ 4. 8	○	○	○	○
φ 6. 0	○	○	○	—

C Sensor Protection Pipe Length

The protection pipe is available in 50 millimeter units in lengths from 50mm to 2000mm.

D Sensor Cable Length

The sensor cable is available in 1 meter units in lengths from 1 meter to 99 meters.

Materials: ①Sensor (Pt100) ②Stainless Protection Pipe (SU316) ③Sleeve (SU304)
④Teflon Shielded Wires ⑤Vinyl Coated Wires ⑥Crimp Terminals

※1: Stated thermal constant time is for sensors with a protection pipe diameter of φ 3.2.

Product Specification

Unit	TR-81
Measurement Channels	Temperature Channel x 2
Measurement Range	-200 to 600°C
Accuracy	±0.3°C (-200 to 80°C) · ±0.5°C (80 to 450°C) · ±1.0°C (450 to 600°C)
Resolution	0.1°C
Adaptable sensors	Pt100 with 3 wires
Measuring current	1mA
Recording Intervals	1,2,5,10,15,20,30 seconds,1,2,5,10,15,20,30,60 minutes/ Total 15 choices
Recording Data Capacity	8000 Readings × 2 channels
Recording Method	Endless Method (Overwrite from the oldest data when recording capacity is full) One-time Method (Stop recording when recording capacity is full)
LCD Display	Current Temperature, Recording Indicator, Battery Life Warning, Data Amount, Unit of Temperature, Communication Indicator, Sensor Type, Recording Methods
Battery	Lithium Battery (CR-2) × 1
Battery Life	Approx. 5 to 8 months (Battery life differs depending on measurement environment and battery performance. Changing battery is possible even during recording.)
Data Back-up	Activated if: Low Battery Power / Switched OFF
Interface	Serial Communication (RS-232C)
Communication Speed	Download at 9,600 bps (40 Sec. / per Unit when data is full)
Dimensions	H123mm x W58mm x D33mm excluding protrusions
Weight	Approx.132g (Including 1 Lithium Battery)
Temperature and Humidity	Temperature: -10 to 60°C
Durability of the Unit	Humidity: Less than 90%RH (Without dew condensation)
Accessories	Lithium Battery (CR-2) × 1 / Wall Attachment with screw × 1 Communication Cable (RS-232C D-Sub9 pins cable length 1.5m) × 1 Standard Software (English) × 1 / Instruction Manual for the software × 1 / User's Manual × 1

Software Specifications

Software	Hi for Windows
Compatible Devices	TR-81
Number of Channels	8 Channel Simultaneous Display and Processing
Communication Functions	Recording Start (Programmed Start/ Immediate Start) and Recording Stop/ Recording Settings (Channel Name/Recording Interval/Recording Method) Download Recorded Data
Graph Display	Temperature and Humidity Graphs for each Channel Zoom in, out and scroll with mouse or keyboard Change Channel Colors/ Turn ON and OFF Channel Display
Data Display	Channel Name / Recording Interval / Number of Readings Highest, Lowest and Average Reading / Unit of Measurement. AB Cursor Dates, Times and Data Readings. Calculated Difference between Cursor A and B
File Output	TR-Series Common Data Files (*.trx) / Text File (CSV, etc...) Selected Range: (File for selected time period)
Print Out	Graphs (Color / Monochrome) / Tables
Others	Data Table Display / Calculation Range Settings / Data Maintenance Delete Data by Channel / Re-order data by Channel
Compatible OS	Microsoft Windows 3.1/95/98/Me English Microsoft WindowsNT 4.0 English Microsoft Windows 2000/Xp English
PC/CPU	IBM Compatible with higher than Pentium 90MHz Serial Port (RS-232C D-sub 9pin)
Memory	More than 8 MB (16MB recommended)
Hard Disk	More than 1 MB of free space (Data will need more space)
Monitor	VGA(640x480) / more than 256 colors

One Touch Sensor Connector

Unit	TR-08P1	Operating Temp. and Humidity	-10 to 60°C below 90%RH
Size of Unit	H42mm x W32mm x D33mm (dimension of flat area)	Accessory	Connection Cable (30cm) × 1 / User's Manual × 1
Weight of Unit	Approx.70g (Main Unit Only)		

System Setup

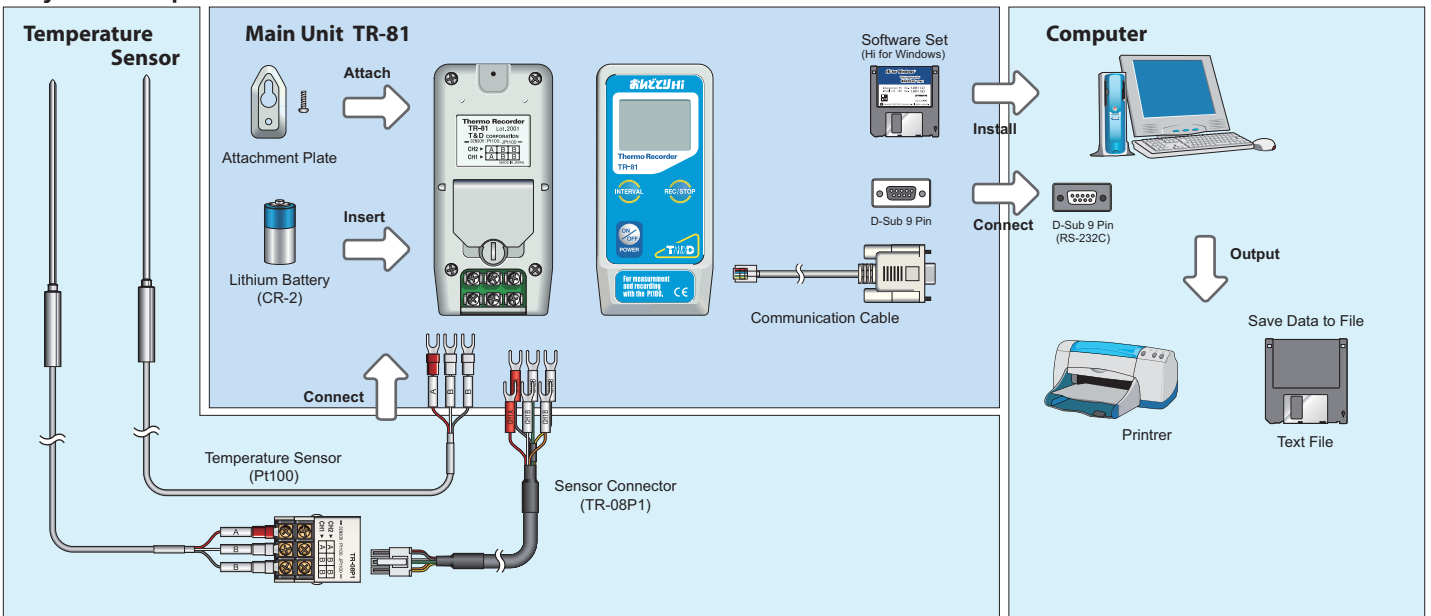

Caution regarding safety To ensure safe operation, carefully read instructions before using this unit.

Web Site
Tashika Online

Product information and FAQ.

<http://www.tashika.co.jp/>

Colors in the photos in this catalog may be different from real product colors. The specification and designs of the products in this catalog are true as of April 2009. Specifications are subject to change without notice. Microsoft®, Windows® and Excel® are registered trademarks of Microsoft Corporation USA and other countries. Company names and product names are trademarks or registered trademarks of each company. Teflon® is a registered trademark of the Dupont Corporation and of the Mitsui Dupont Fluoro-chemical Corporations. Lotus® is a registered trademark of the Lotus Development Corporation. Pentium® is a registered trademark of the Intel America Corporation.

TASHIKA CO., LTD.

1-12, Kaiyo-cho, Ashiya, 659-0035, JAPAN

Tel: + 81-797-23-9035 Fax: + 81-797-23-2105

e-mail: sales@tashika.co.jp URL: www.tashika.co.jp

■Distributor